



INSTITUT FRANÇAIS D'ARCHÉOLOGIE ORIENTALE

المعهد الفرنسي للآثار الشرقية

Submission of an article to the BIFAO

(Deadline: 03/31)

You wish to submit an article to the BIFAO. Before addressing it to the editorial department (bkasparian@ifao.egnet.net), please:

1. make sure that it adheres to the following guidelines:
 - 1.1. compliance with the editorial rules of the Ifao, available online:
<http://www.ifao.egnet.net/publications/publier/normes-ed/>
 - 1.2. compliance with the bibliographical rules of the Ifao, available online:
<http://www.ifao.egnet.net/publications/publier/normes-ed/>
 - 1.3. use of the unicode font for special characters: use of the unicode keyboard, downloadable on the Ifao website:
<http://www.ifao.egnet.net/publications/publier/outils-ed/polices/>;
or use of the converter to unicode:
<http://www.ifao.egnet.net/publications/publier/outils-ed/convertisseurs/>
 - 1.4. as for the hieroglyphs composed using Jshesh:
 - cut/paste the hieroglyphs from JSesh in EMF format (Windows) or PDF format (Mac OsX)
 - insert each sequence (even if exactly the same sequence has already been inserted) from Jshesh (ensure that you DO NOT copy and paste hieroglyphs from Word)
 - 1.5. compliance with the iconographical recommendations: native files in JPEG or TIFF format using high resolution, Illustrator files for computerised figures, preliminary layout (size of the figure: full page, eighth, quarter or half a page, location within the text, etc), copyrights
 - 1.6. specify whether the illustrations are placed within the text or set apart
2. provide an anonymised version of your text
3. mention your titles, functions and addresses (both institutional and electronic)
4. provide two summaries, one in French and one in English (900 characters for each of them), as well as a list of keywords in both languages

Any submission that does not comply with the guidelines here above mentioned will be sent back to the author.

NB: Drawings of objects (particularly ceramic ones) must comply with the following rules:
 - drawings (please ensure that they conform, as far as possible, to the model hereafter):

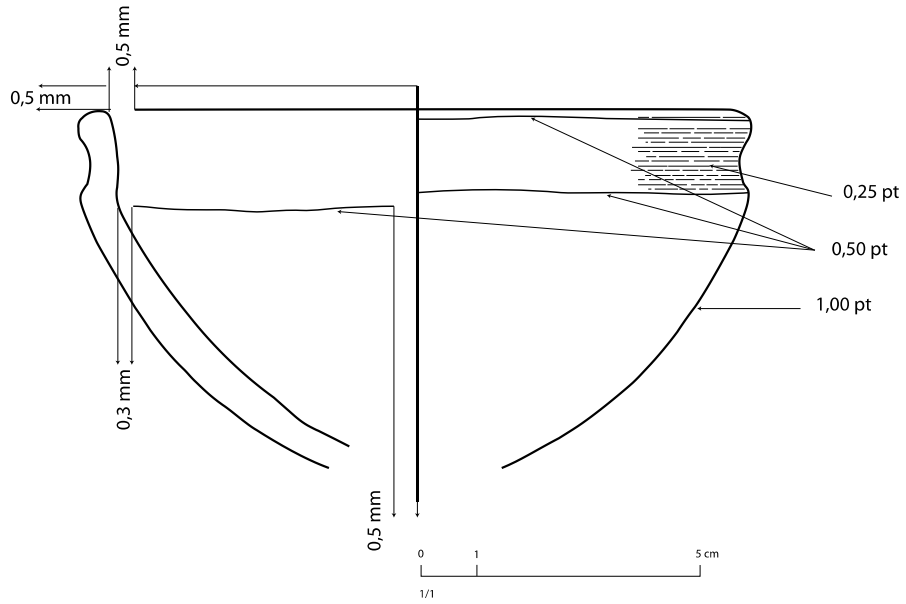





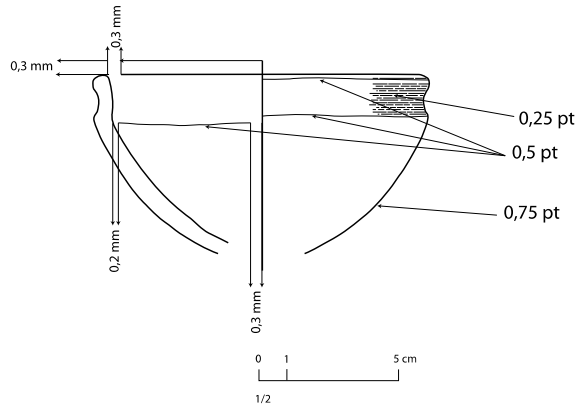



1/1

Le texte doit être composé en Myriad Pro



1/2

Noir		80 %
Marron - Brun		60 %
Vert		50 %
Rouge		45 %
Bleu		40 %
Orange		30 %
Jaune		25 %
Blanc		15 %

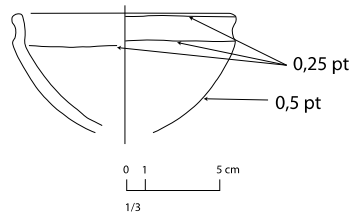

1/3

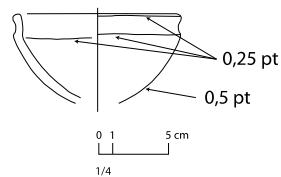

1/4

- the metric scale (the metric scale set out hereafter shall be used):

Échelles 1/1

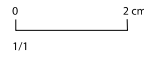
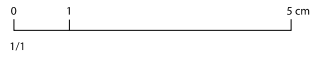
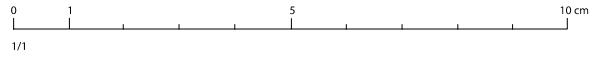

Échelles 1/2

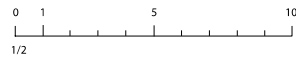

Échelles 1/3

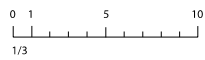

Échelles 1/4

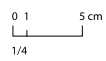
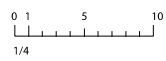

To obtain the source illustrator files, please contact:
bkasparian@ifao.egnet.net or smarchand@ifao.egnet.net